

- (D) Befolgen Sie stets die Anleitung des Herstellers!
- (GB) Please generally follow the manufacturer's instructions!
- (FR) Suivez toujours les instructions du fabricant!
- (NL) Volg steeds de handleiding van de producent!
- (ES) Siga siempre las instrucciones del fabricante!
- (PL) Stale przestrzegaj instrukcji producenta!

- (RU) Всегда следуйте инструкции производителя!
- (IT) Seguire sempre le istruzioni del produttore!
- (HU) Mindig tartsa be a gyártó utasításait!
- (P) Siga sempre as instruções do fabricante!
- (CZ) Vždy dodržujte pokyny výrobce!

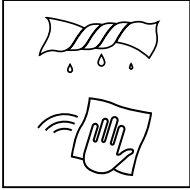

- (D) Verwenden Sie zur Reinigung nur ein feuchtes Tuch!
- (GB) Please only clean with a damp cloth!
- (FR) N'utilisez qu'un chiffon humide pour le nettoyage!
- (NL) Gebruik voor de reiniging enkel een vochtige doek!
- (ES) Para limpiar utilice sólo un paño húmedo!
- (PL) Do czyszczenia używaj wilgotnej szmatki!

- (RU) Для очистки используйте только влажную ткань!
- (IT) Per la pulizia, utilizzare solo un panno umido!
- (HU) A tisztításhoz elegendő egy nedves kendő használata!
- (P) Para a limpeza use apenas um pano húmido!
- (CZ) Pro čištění používejte pouze vlhký hadřík!

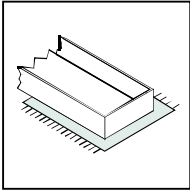

- (D) Bauen Sie das Produkt auf einer Unterlage auf!
- (GB) Please mount the product on a bottom support!
- (FR) Montez le produit sur une base!
- (NL) Monteer het product op een basis!
- (ES) Monte el producto sobre una base!
- (PL) Rozkładaj produkt na podkładce!

- (RU) Собирайте изделие на подстилке!
- (IT) Montare il prodotto su un supporto!
- (HU) Az összeszereléskor helyezzen a termék alá megfelelő alátétet!
- (P) Monte o produto numa superfície plana!
- (CZ) Výrobek smontujte na pevném podkladu!

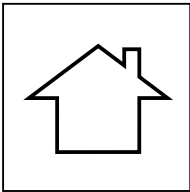

- (D) Verwenden Sie das Produkt nur in Innenräumen!
- (GB) Please exclusively use the product indoors!
- (FR) N'utilisez le produit qu'à l'intérieur!
- (NL) Gebruik het product enkel binnenshuis!
- (ES) Utilice el producto sólo en interiores!
- (PL) Używaj produkt tylko w pomieszczeniach wewnętrznych!

- (RU) Используйте изделие только во внутренних помещениях!
- (IT) Utilizzare il prodotto solo in ambienti interni!
- (HU) A termék csak bel terekben használható!
- (P) Use o produto apenas no interior!
- (CZ) Používejte výrobek pouze uvnitř!

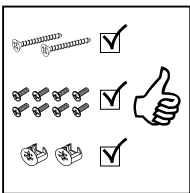

- (D) Legen Sie die Beschläge zusammen und prüfen Sie die Vollständigkeit!
- (GB) Please join the fittings and verify their completeness!
- (FR) Pliez les raccords ensemble et vérifiez qu'ils sont complets!
- (NL) Leg de onderdelen samen en controleer de volledigheid!
- (ES) Junte los accesorios y compruebe que están todos!
- (PL) Rozłóż poszczególne części i sprawdź kompletność!

- (RU) Положите фурнитуру в одно место и проверьте комплектность!
- (IT) Mettere insieme le guarnizioni e verificarne la completezza!
- (HU) Állítsa össze a sarokvasakat, és ellenőrizze, hogy épek-e!
- (P) Coloque os encaixes juntos e verifique se estão completos!
- (CZ) Složte armatury a zkontrolujte úplnost!

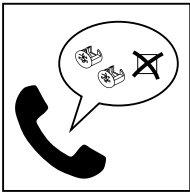

- (D) Bei fehlenden Teilen kontaktieren Sie den Hersteller!
- (GB) If parts are missing, please turn to the manufacturer!
- (FR) En cas de pièces manquantes, veuillez contacter le fabricant!
- (NL) Contacteer de fabrikant als er onderdelen ontbreken!
- (ES) En el caso de que falten piezas, póngase en contacto con el fabricante!
- (PL) W razie braku części skontaktuj się z producentem!

- (RU) При отсутствии каких-либо частей обратитесь к производителю!
- (IT) In caso di pezzi mancanti, contattare il produttore!
- (HU) Ha hiányozna valamely k elem, lépjen kapcsolatba a gyártóval!
- (P) Em caso de peças em falta, entre em contato com o fabricante!
- (CZ) Pro chybějící díly kontaktujte prodejce!

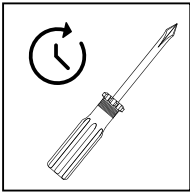

- (D) Ziehen Sie die Schrauben nach einiger Zeit des Gebrauchs erneut fest!
- (GB) Please re-tighten the screws after having used the product for a while!
- (FR) Resserrer les vis après un certain temps d'utilisation!
- (NL) Draai de schroeven na een zekere gebruikstijd opnieuw vast!
- (ES) Asegure de nuevo los tornillos tras usarlo durante un tiempo!
- (PL) Po pewnym czasie użytkowania ponownie dokręć śruby!

- (RU) Спустя некоторое время использования подкрутите гайки!
- (IT) Stringere nuovamente le viti dopo un certo periodo di utilizzo!
- (HU) A használat során némi idő elteltével húzza meg újra a csavarokat!
- (P) Reaperte os parafusos após algum tempo de uso!
- (CZ) Po určité době používání šrouby znovu utáhněte!

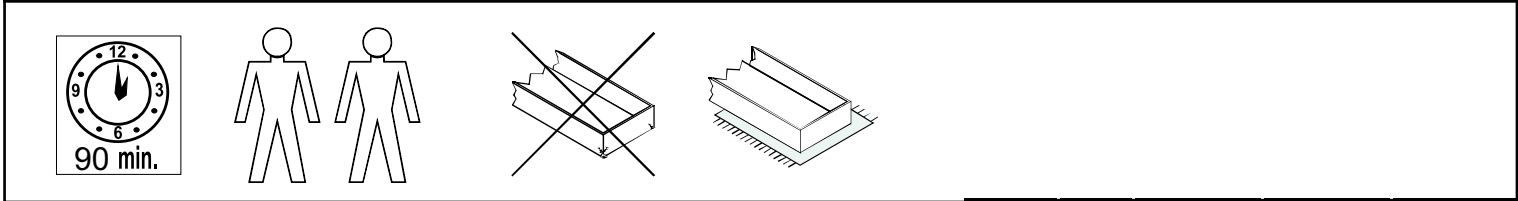

rozměry v mm				
①	1×	1800	350	18
②	1×	1800	350	18
③	1×	264	332	18
④	1×	264	332	18
⑤	1×	264	300	18
⑥	1×	264	300	18
⑦	1×	450	260	18
⑧	1×	450	260	18
⑨	1×	776	260	18
⑩	1×	1695	275	3

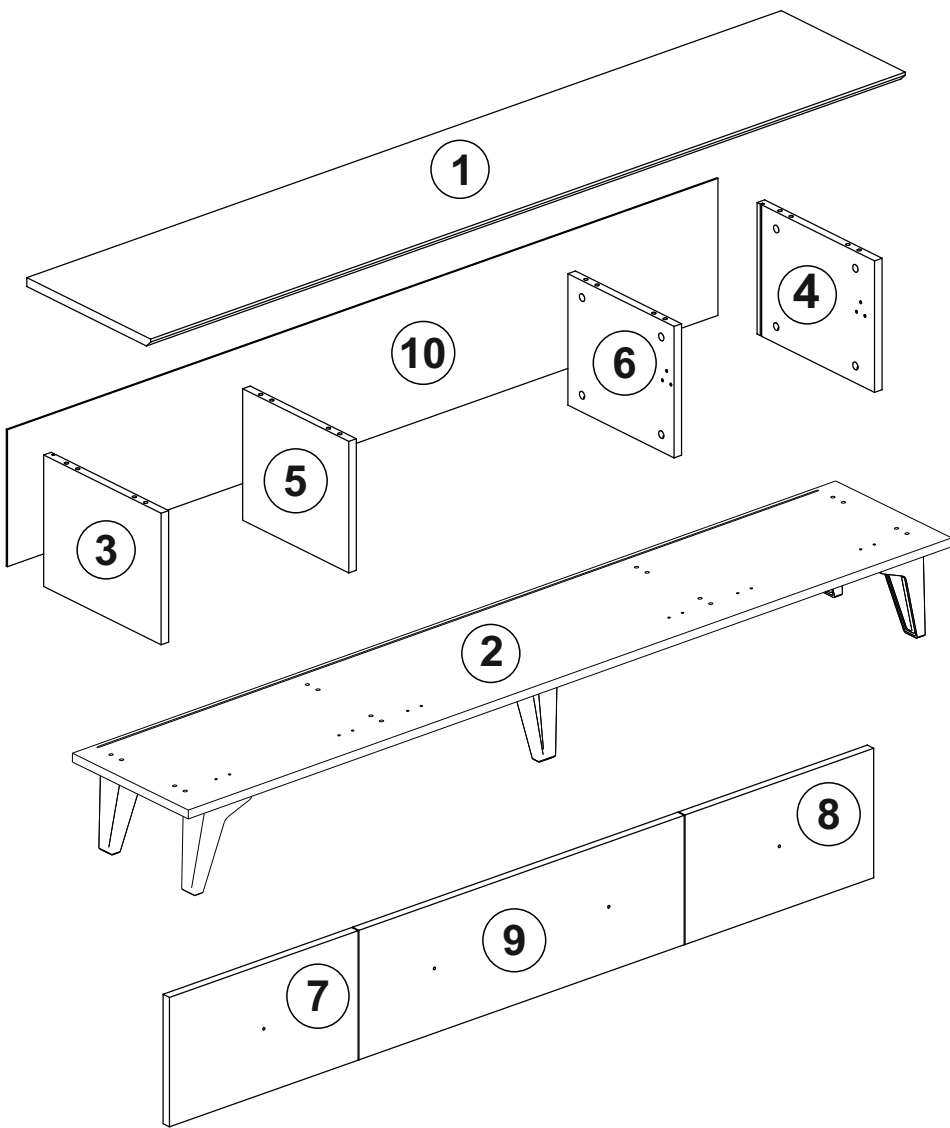

karton 1	1× 1; 1× 2; 1× 3; 1× 4; 1× 5; 1× 6; 1× 7; 1× 8; 1× 9; 1× 10
-----------------	---



karton 1

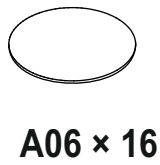
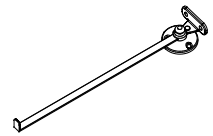
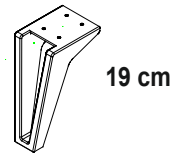
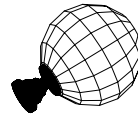
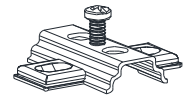
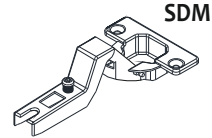
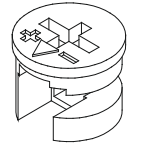
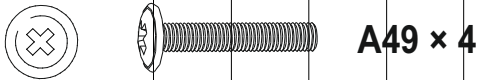
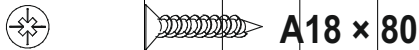
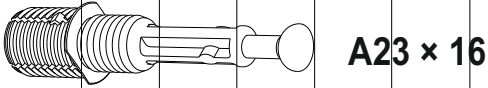

1

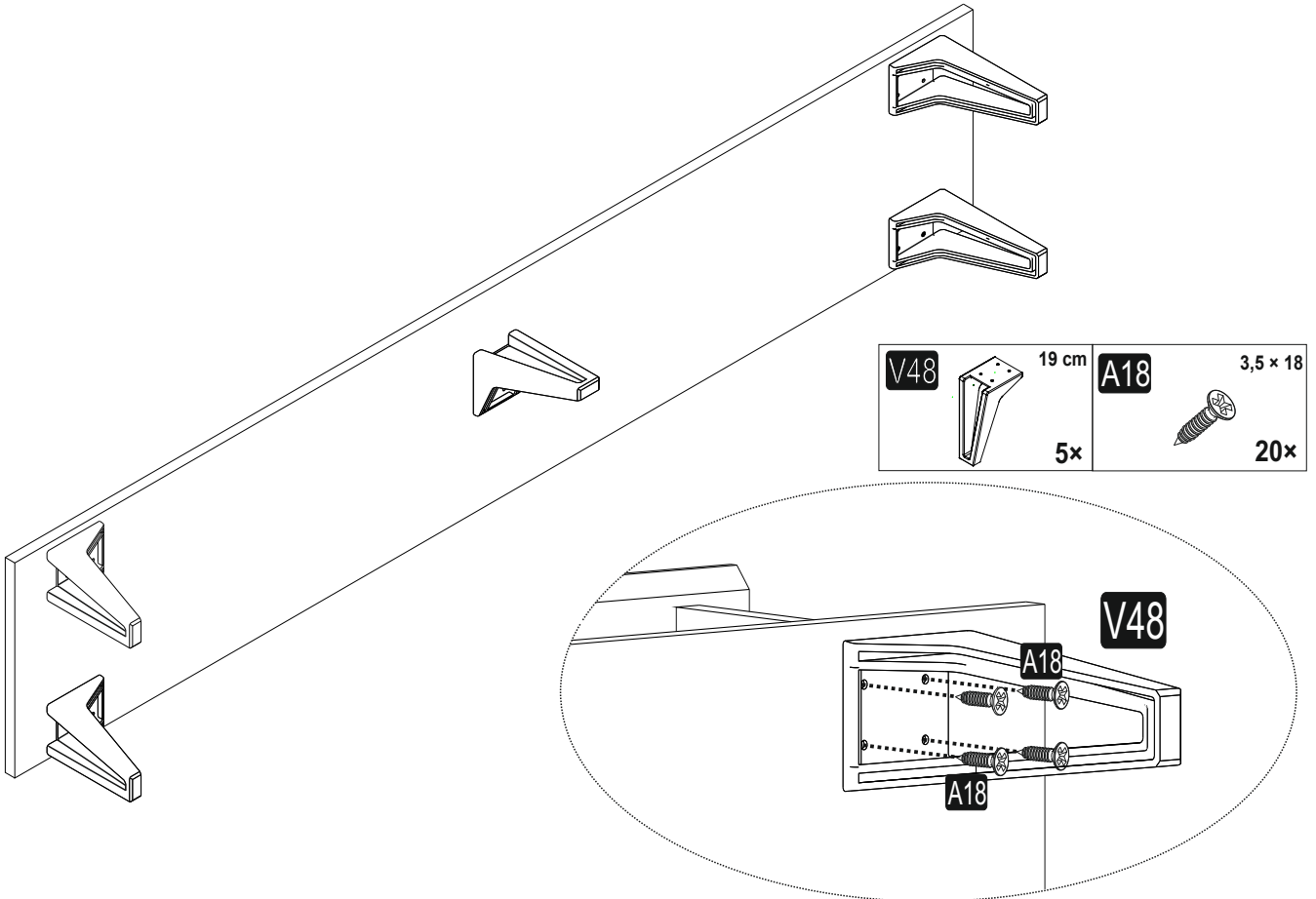

2

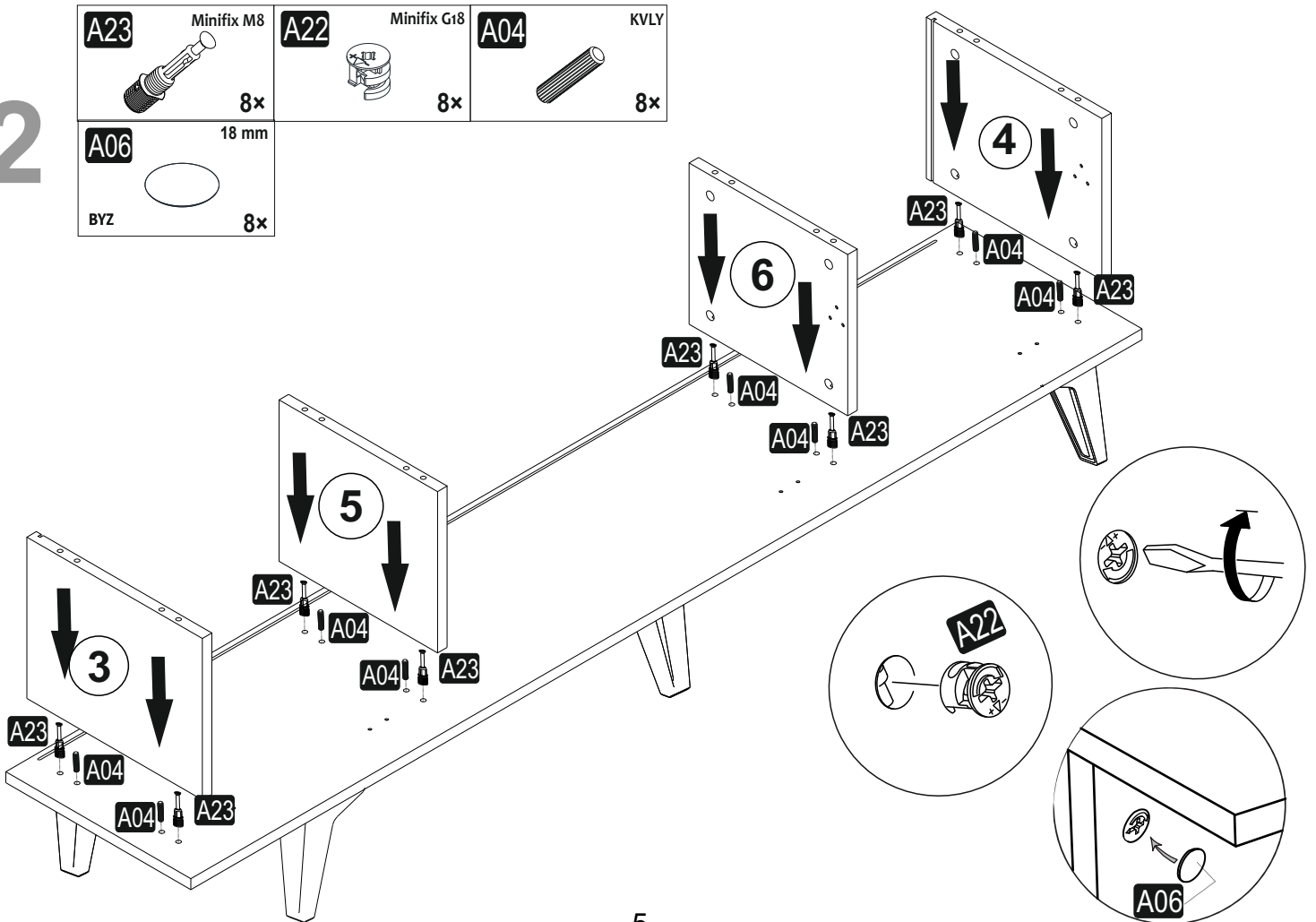

3

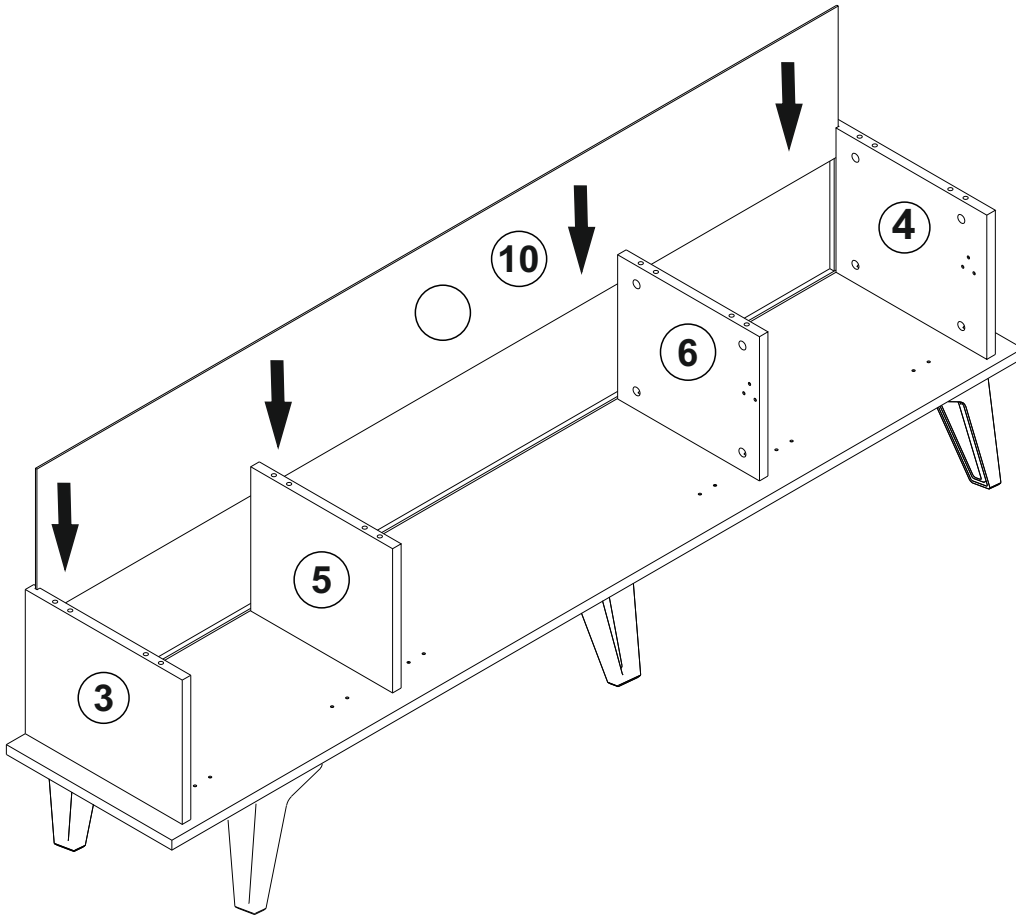

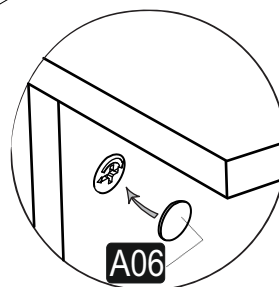
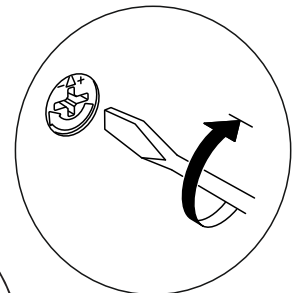
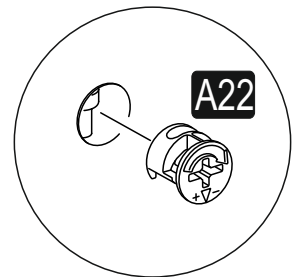
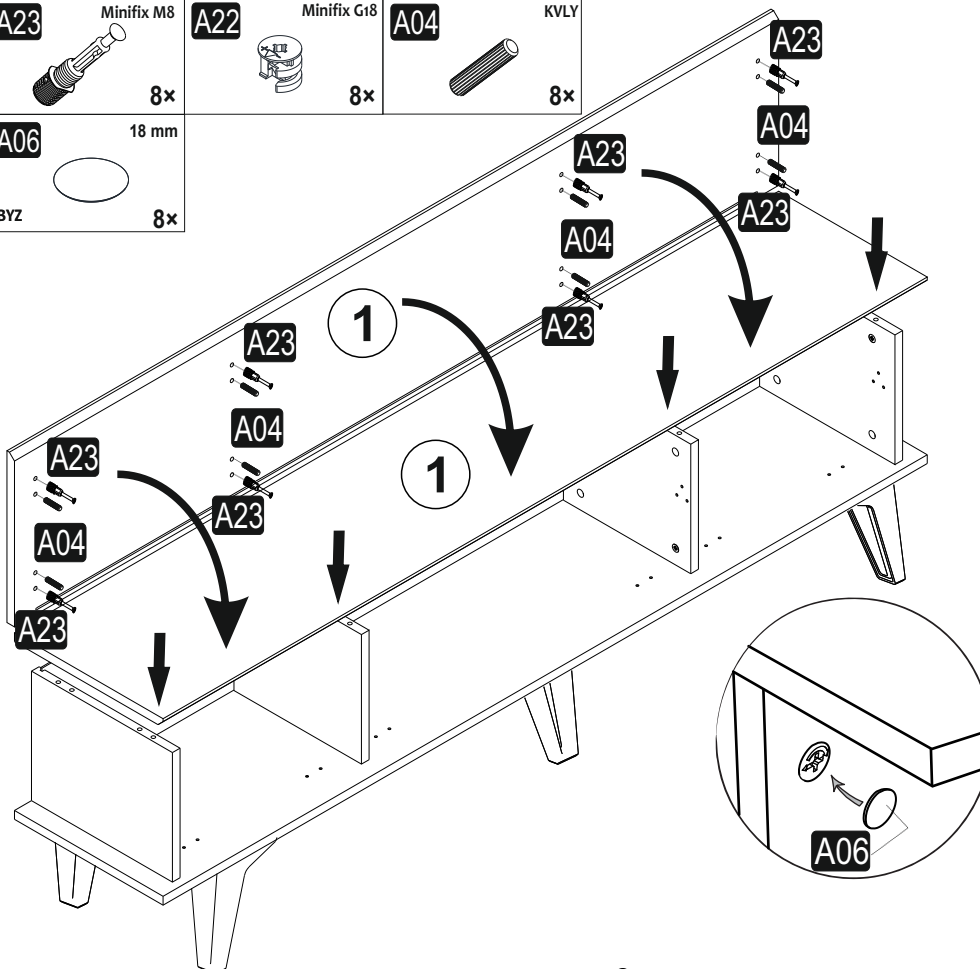

4

A23 Minifix M8 8x	A22 Minifix G8 8x	A04 KVLV 8x
A06 18 mm BYZ 8x		



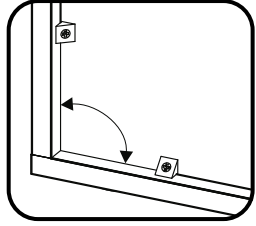
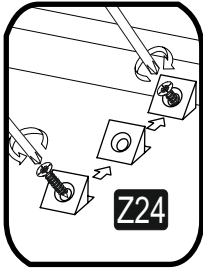
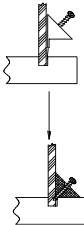
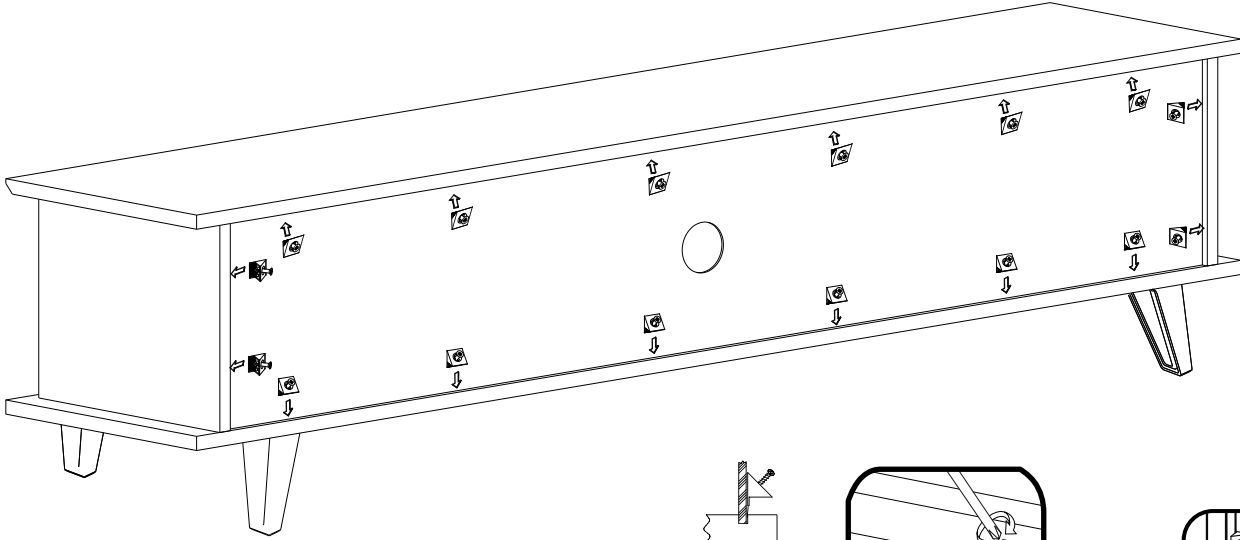

5

Z24  16x	A18 3,5 x 18  16x
--	---



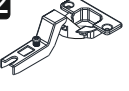
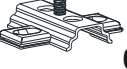

6

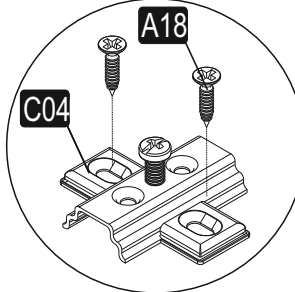
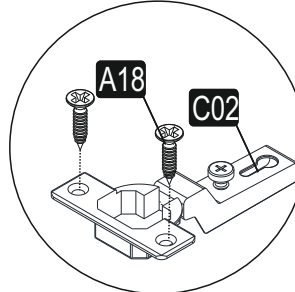
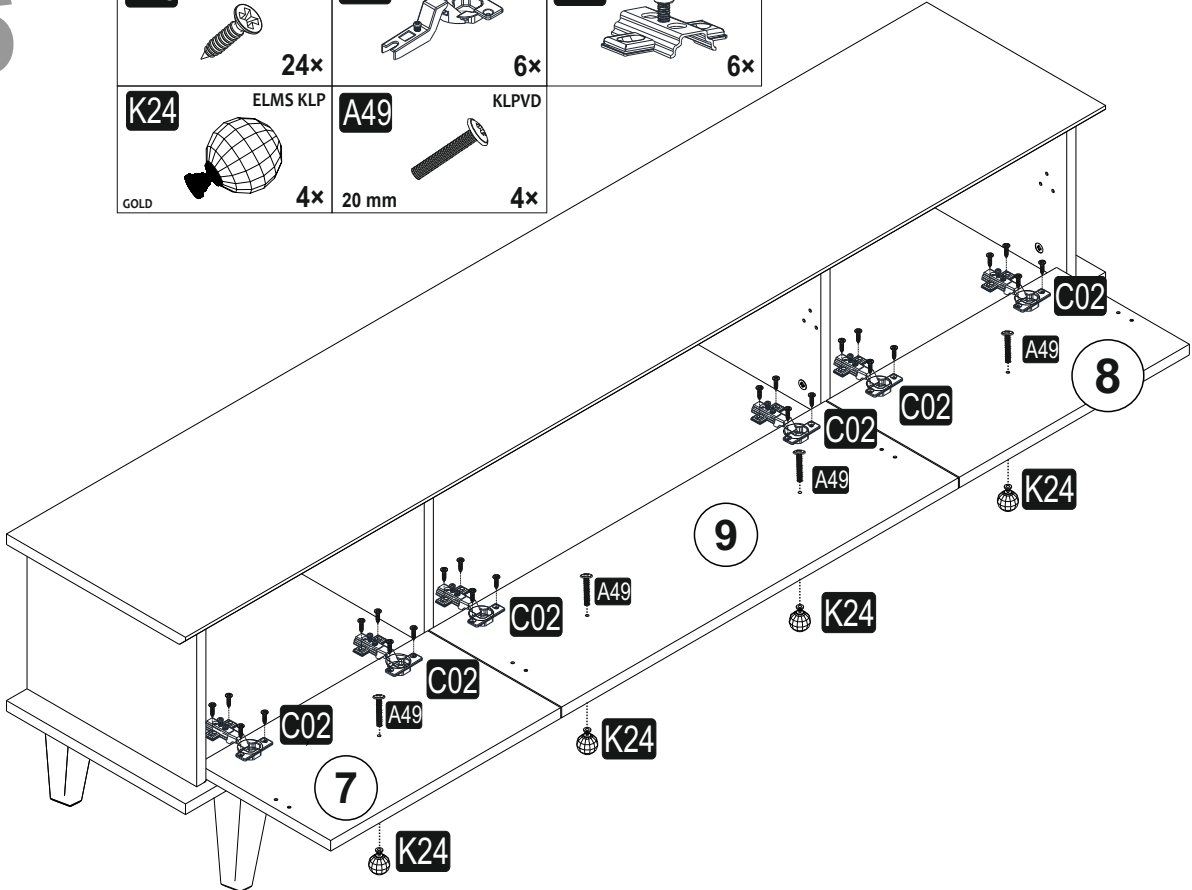
A18 3,5 x 18  24x	C02 SDM  6x	C04 MA  6x
K24 ELMS KLP  4x GOLD	A49 KLPVD  20 mm 4x	



7

A18	3,5 x 18
	20x
V37	DSR KPK
	4x

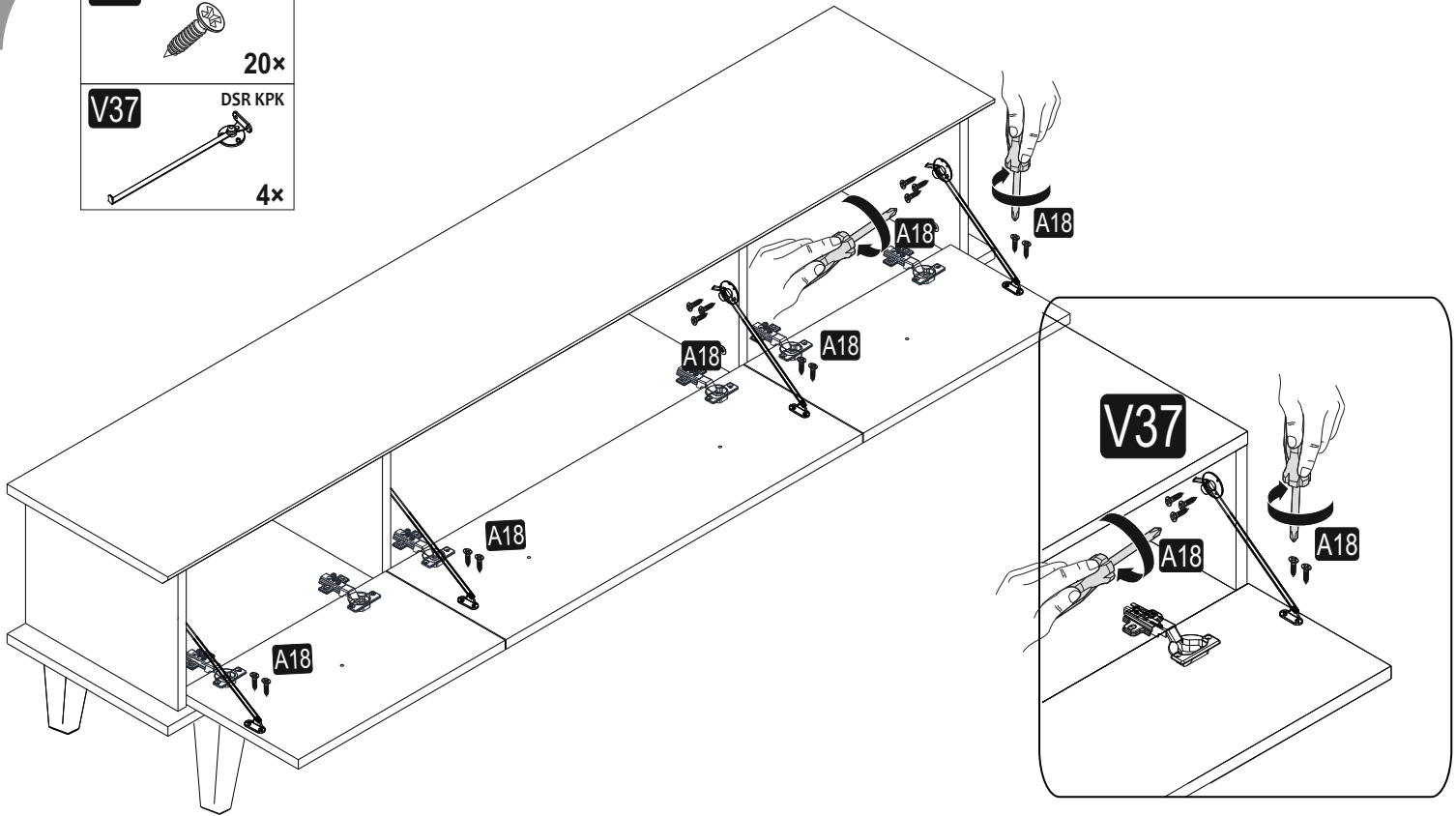

8

