

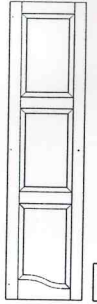

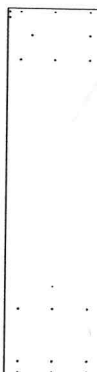

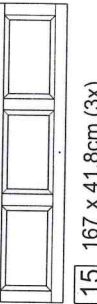

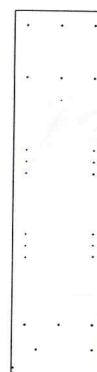

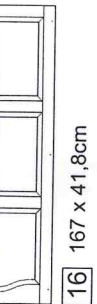





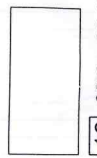



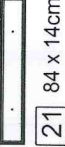

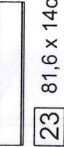

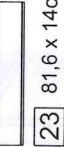

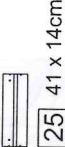
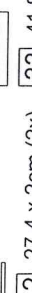















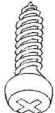

Ref.: 582

	1 205 x 53cm		14 167 x 41,8cm
	2 205 x 53cm		15 167 x 41,8cm (3x)
	3 205 x 52,4cm (2x)		16 167 x 41,8cm
	4 194 x 46,3cm (4x)		17 91,6 x 51,4cm (6x)
	5 194 x 48,8cm		18 47 x 51,4cm (3x)
	6 205 x 6,5cm		19 82,6 x 39,6cm (2x)
	7 205 x 6,5cm		20 47 x 51,4cm (2x)
	8 205 x 6,5cm (2x)		21 84 x 14cm (2x)
	9 94 x 6,5cm (4x)		22 41,8 x 14cm
	10 53,8 x 6,5cm (6x)		23 81,6 x 14cm (2x)
	11 136,2 x 2cm (2x)		24 39,4 x 14cm
	12 27,4 x 2cm (2x)		25 41 x 14cm (6x)
			26 91 x 2,8cm (2x)
			27 84,6 x 6,5cm (4x)
			28 42,4 x 6,5cm (2x)
			29 84,6 x 6,5cm (2x)
			30 42,4 x 6,5cm
			31 91,6 x 6,5cm (2x)
			32 47 x 6,5cm
			33 41,8 x 5,5cm (2x)
			34 41,8 x 3cm (4x)
			35 10 x 2cm (12x)

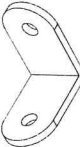
	A x 68 Ø8x30mm		H x 10
	B x 26 Ø8x50mm		J x 15
	C x 146 Ø3,5x14mm		K x 4
	D x 52 Ø3,5x30mm		L x 10
	E x 110 Ø4,0x35mm		Lb
	F x 4 Ø4,5x50mm		M x 2
	G x 10 Ø4,8x19mm		N x 8
			P x 100



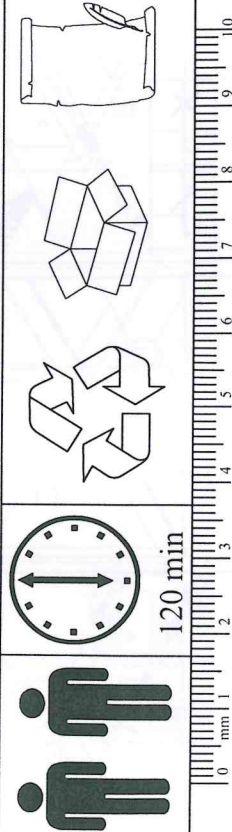
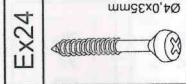

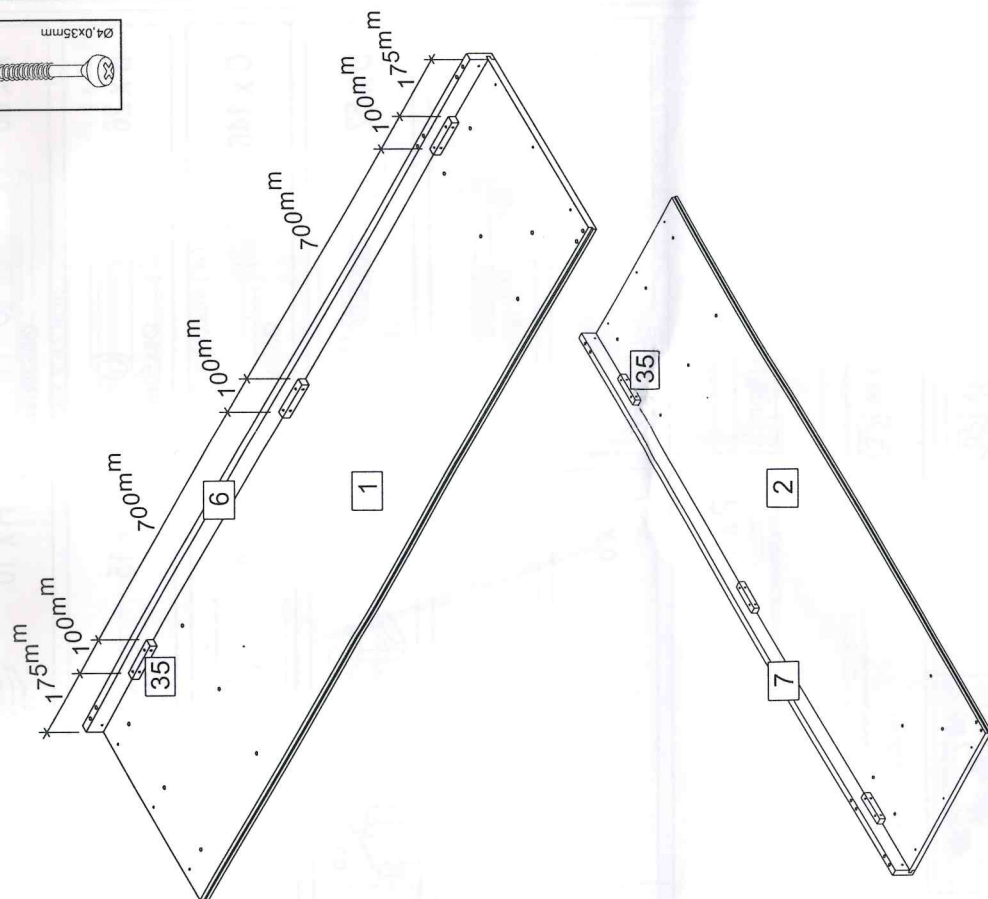

1

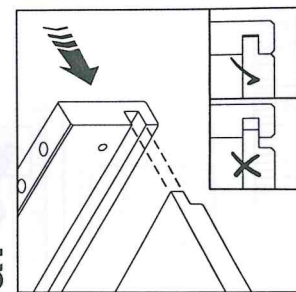

a:



b:

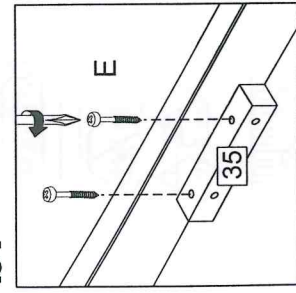

c:

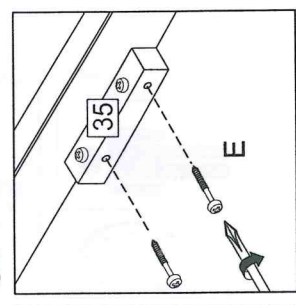

2

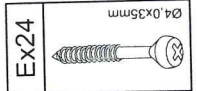

2x

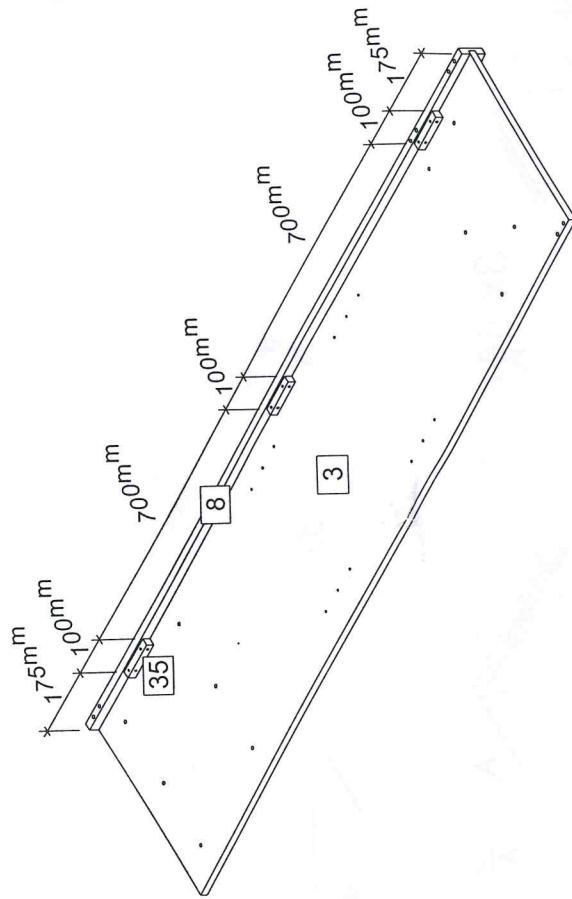

a:

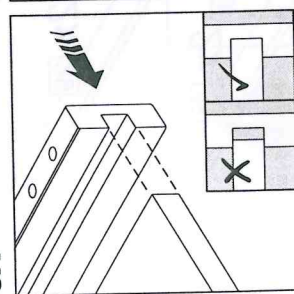

b:

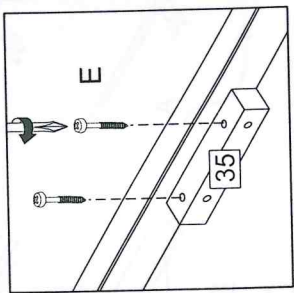

c:

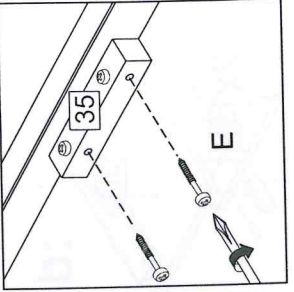

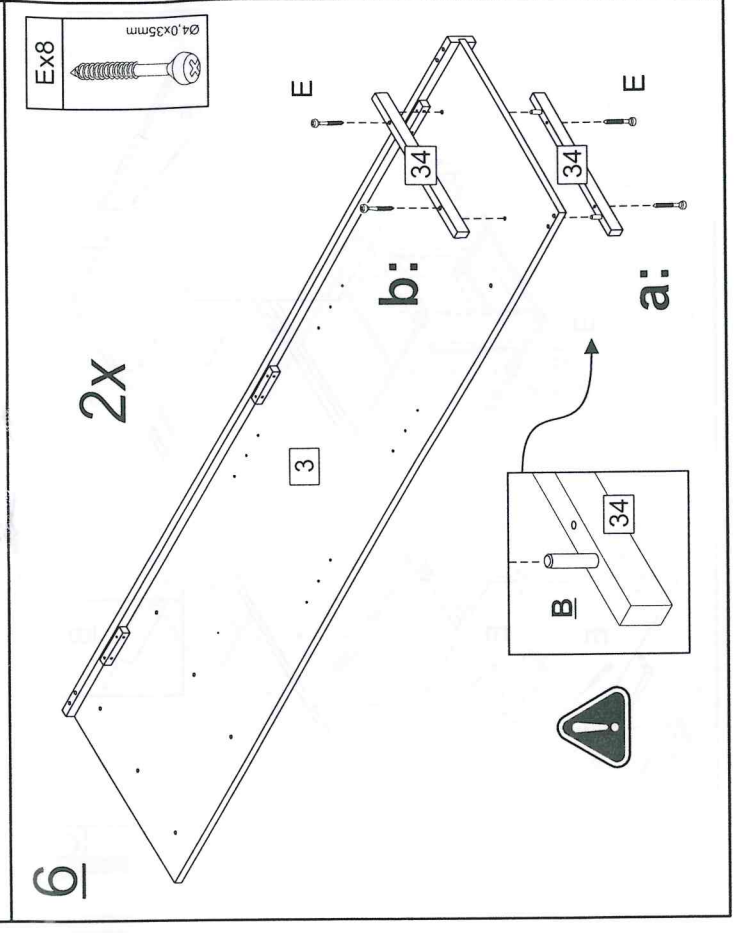
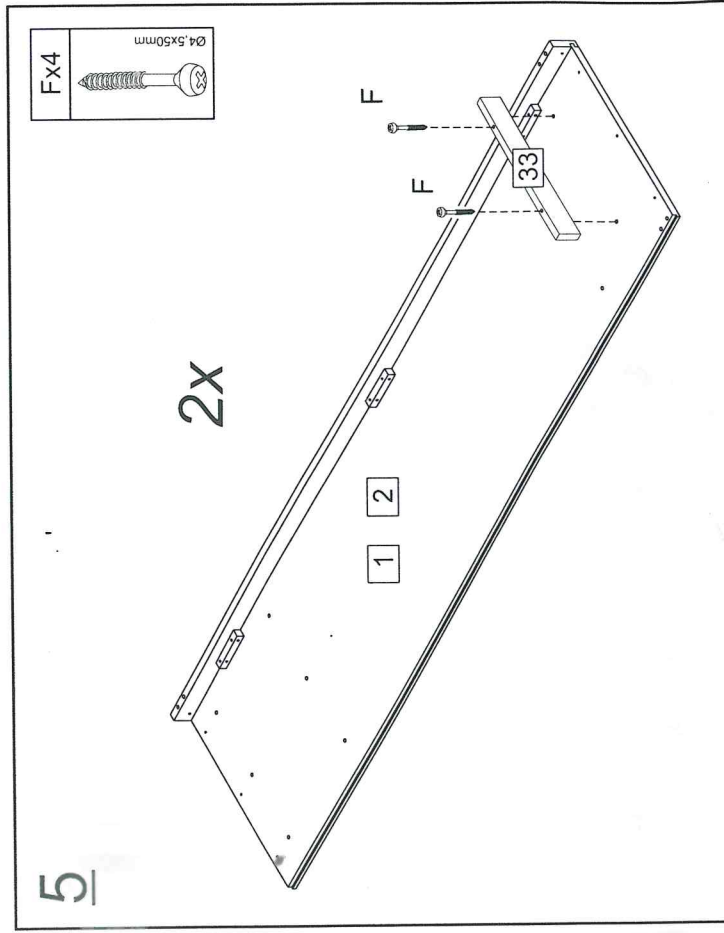
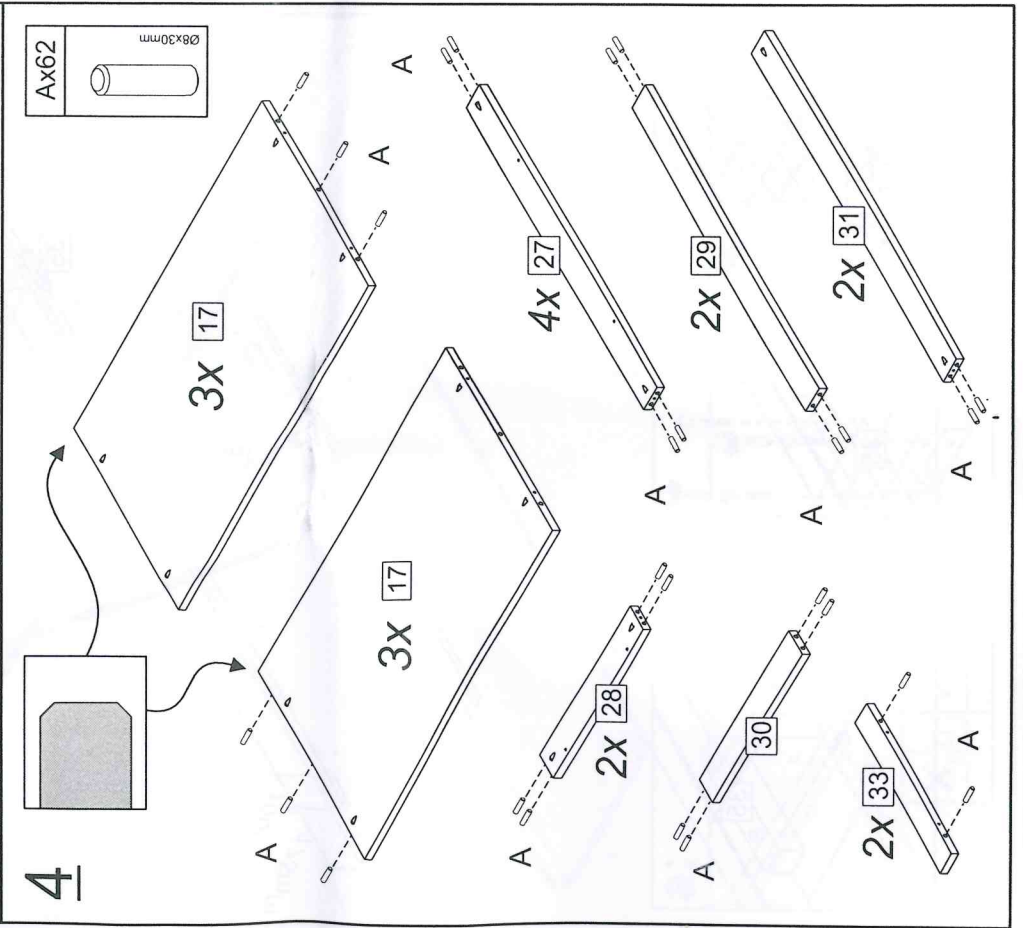
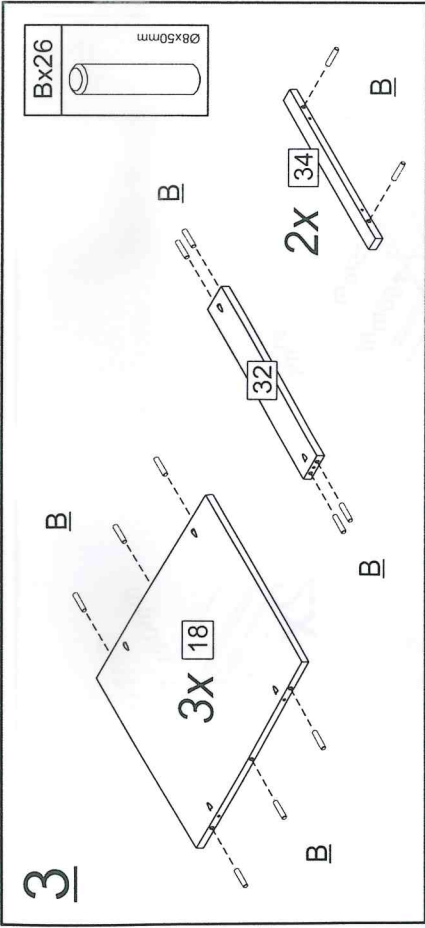

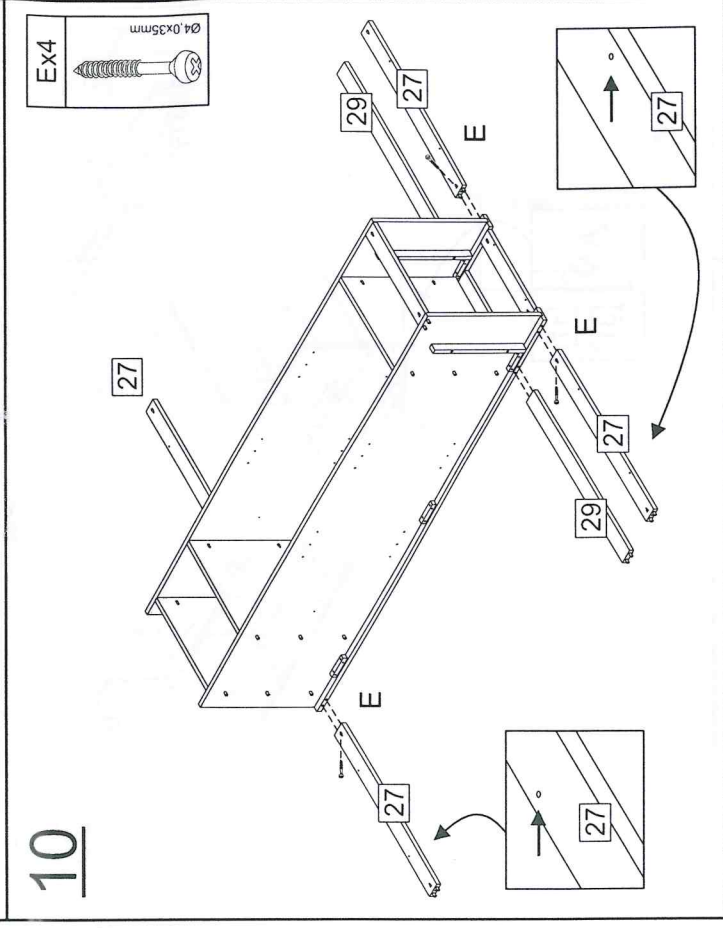
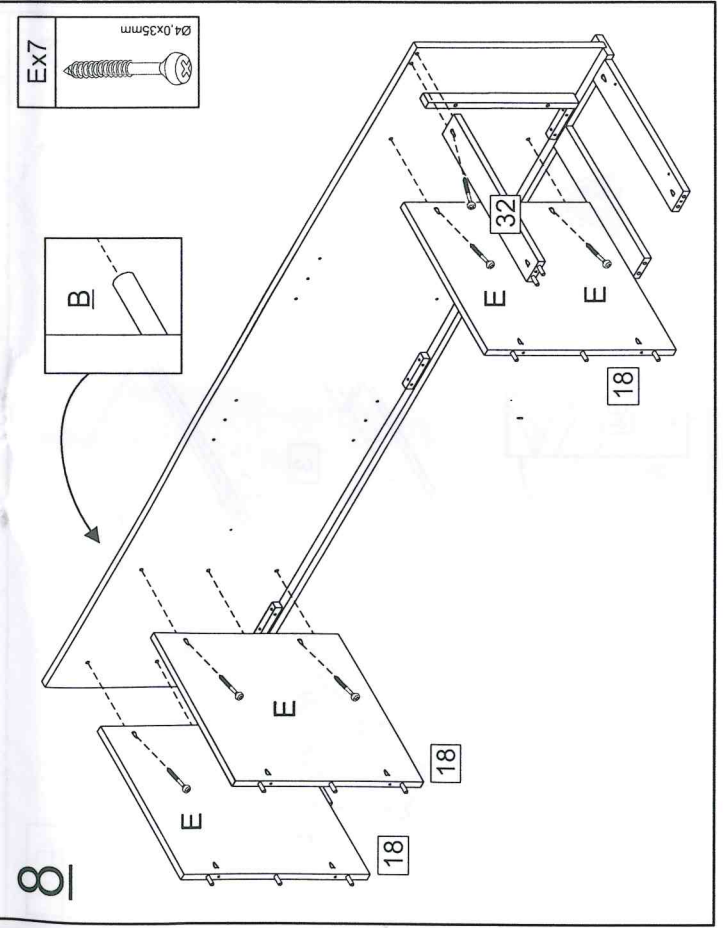
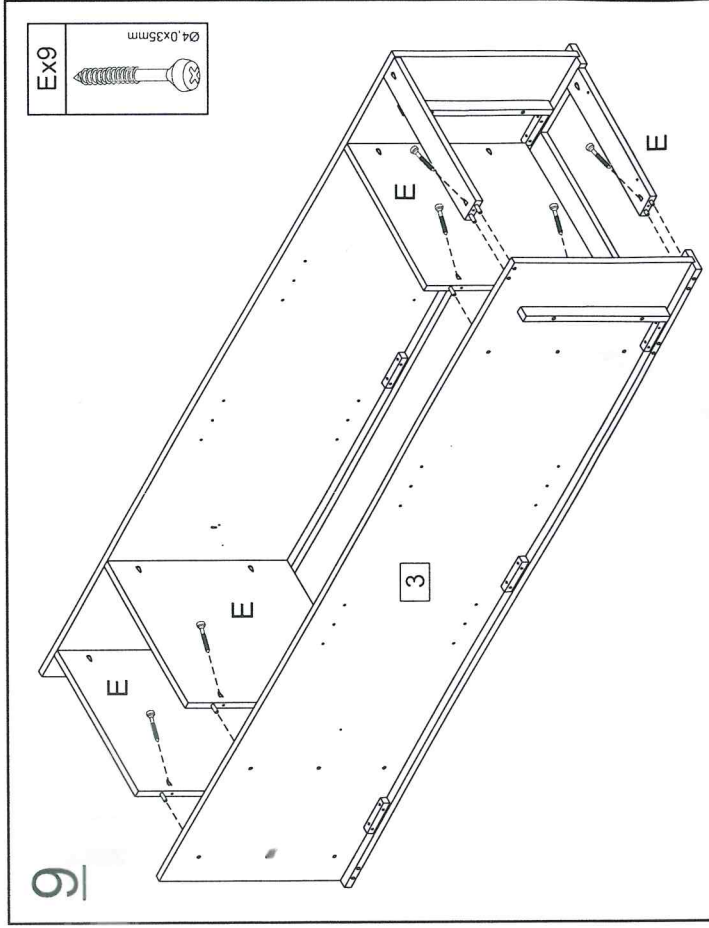
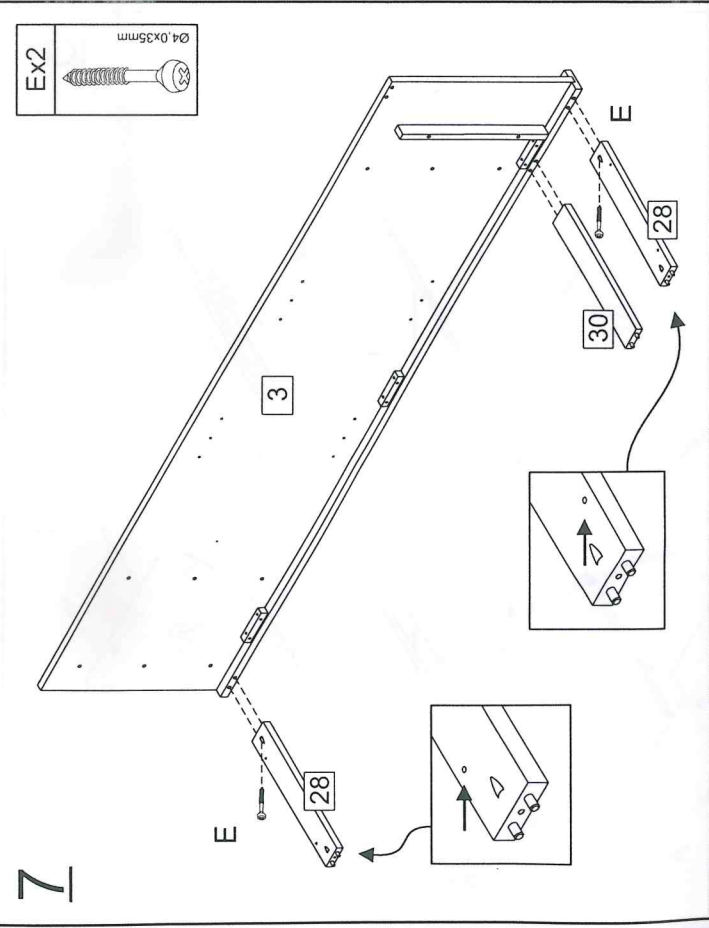

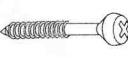

11

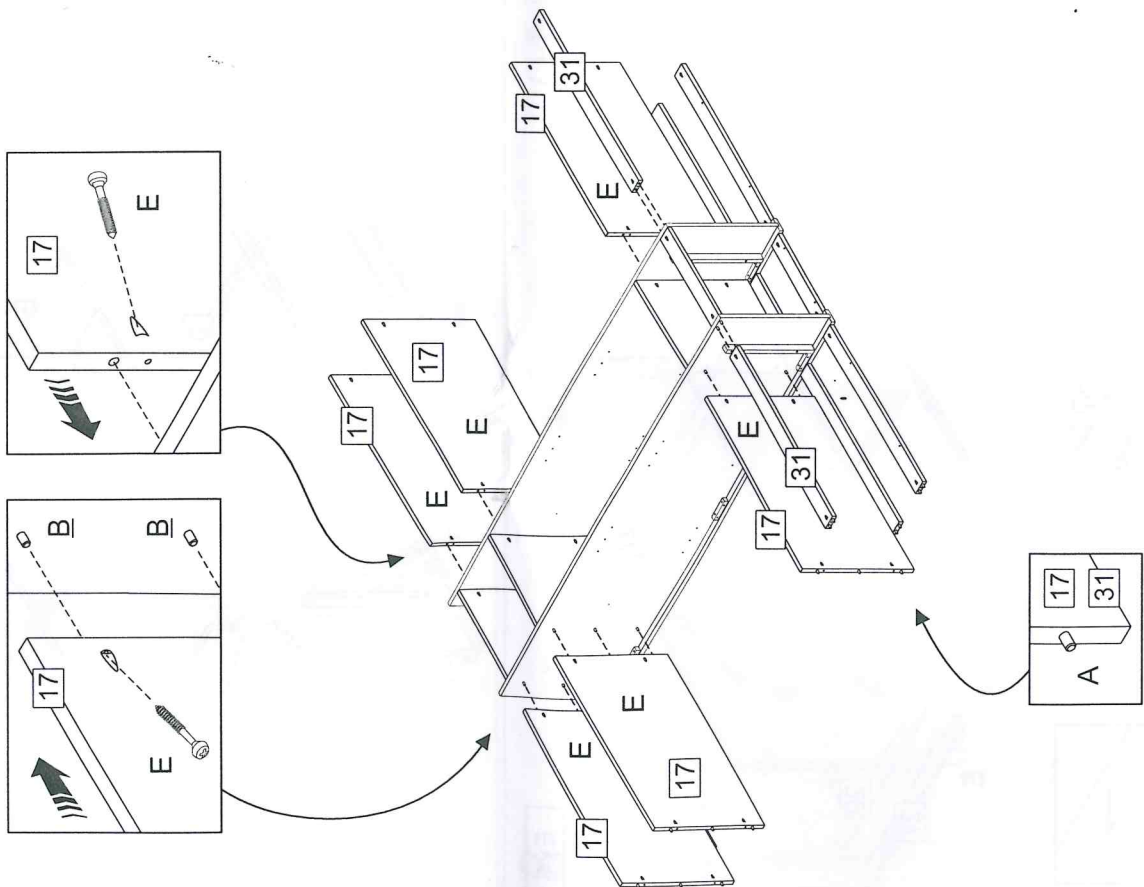
Ex14		Ø4,0x35mm
------	---	-----------



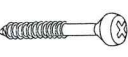
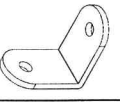

12

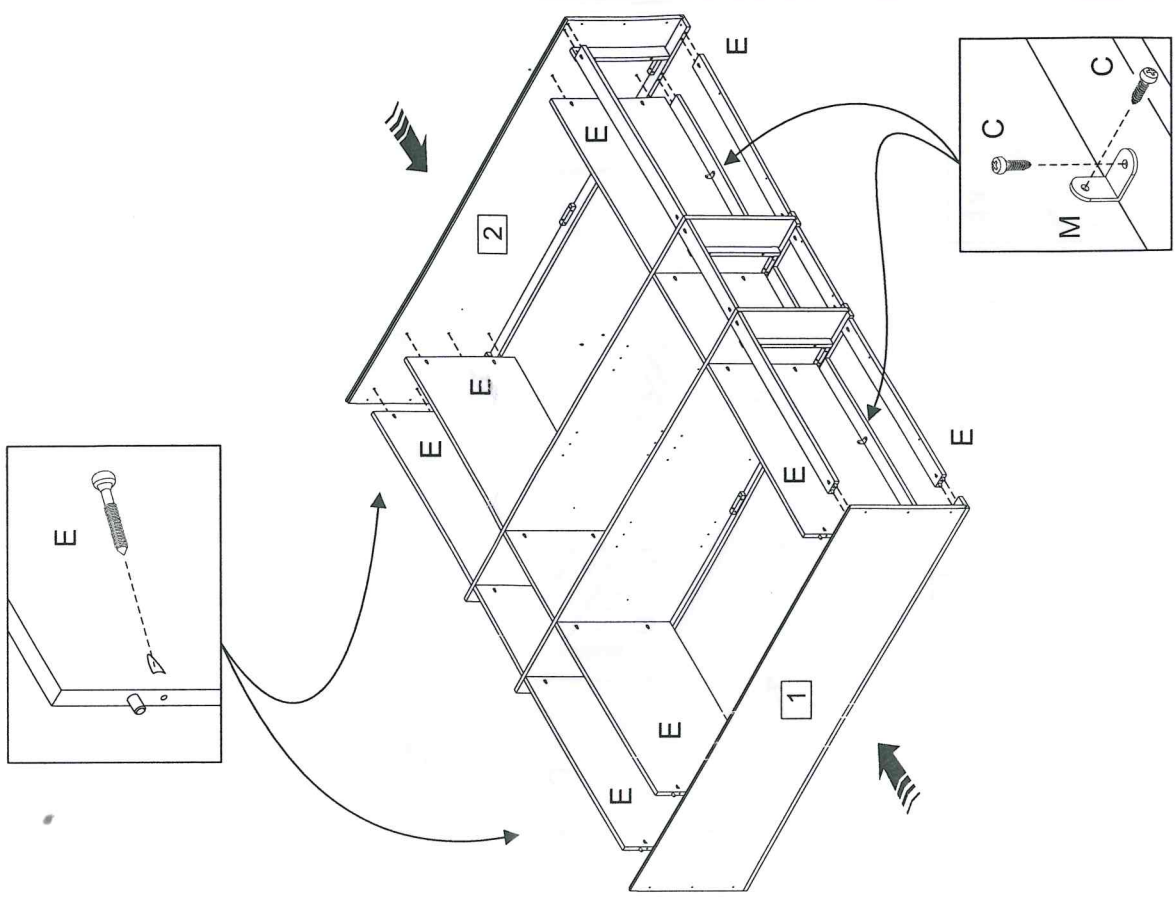
Cx4		Ø3,5x14mm
Ex18		Ø4,0x35mm
Mx2		



14

Cx12	Kx4	Nx8
		

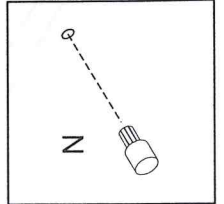
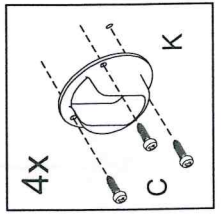
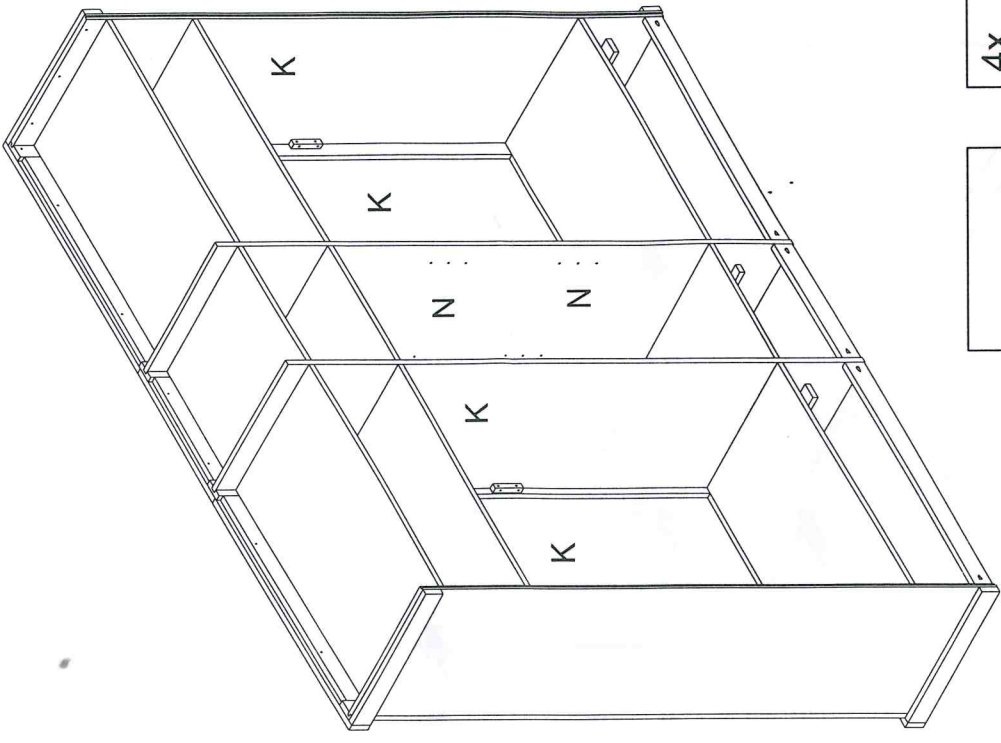



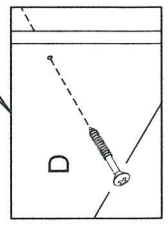
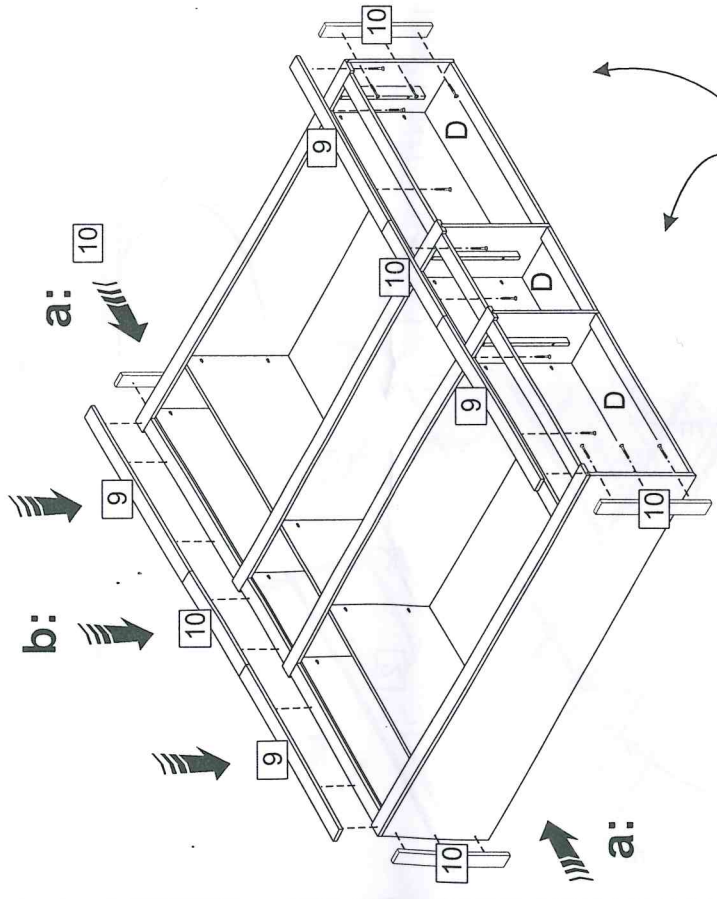

13

Dx28



16

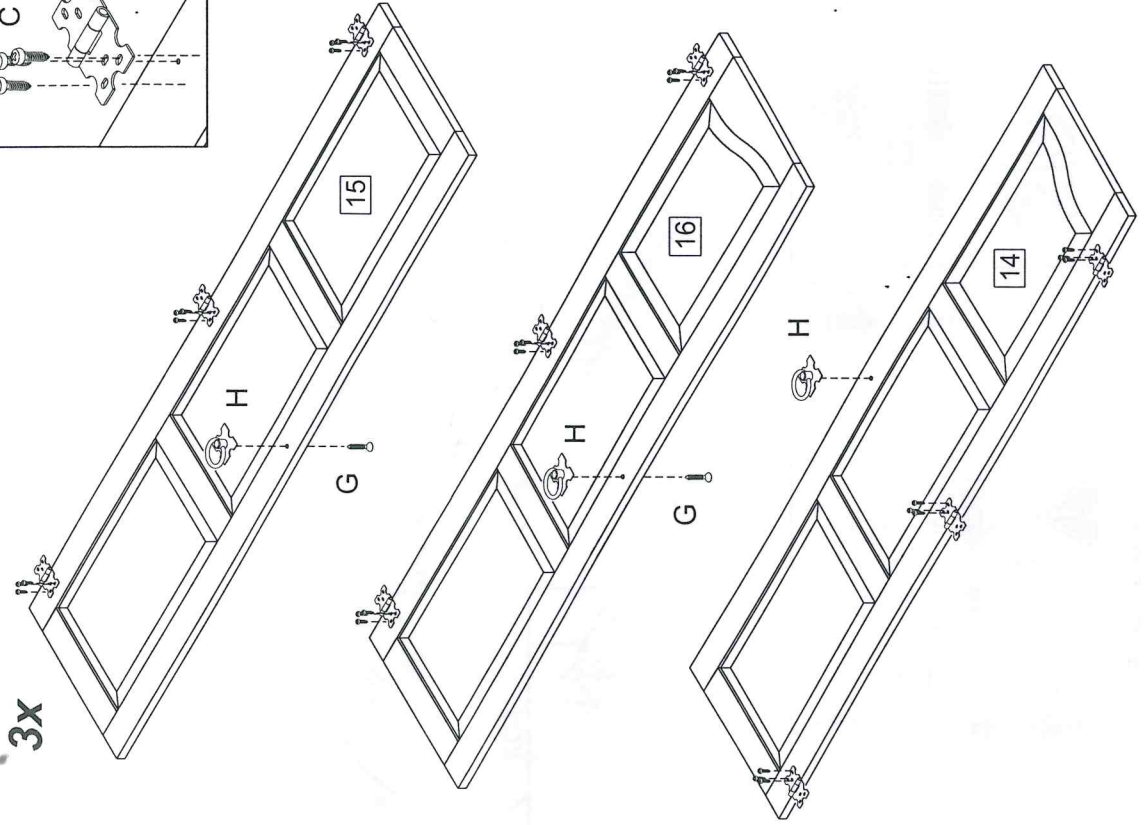
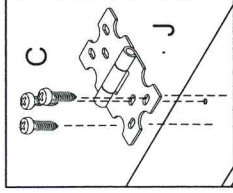

Cx45	Gx5	Hx5	Jx15
			

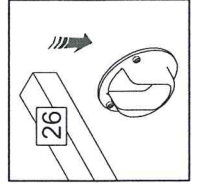
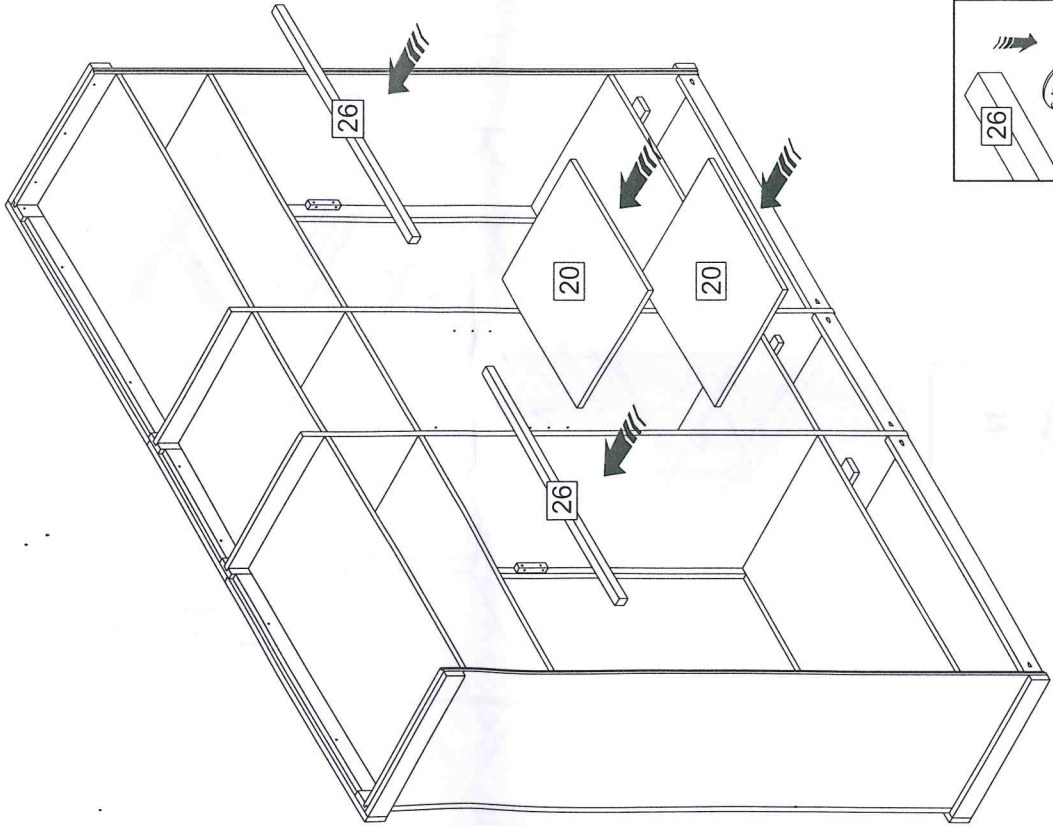

15



18

Cx40	Lax10	Lbx10
		

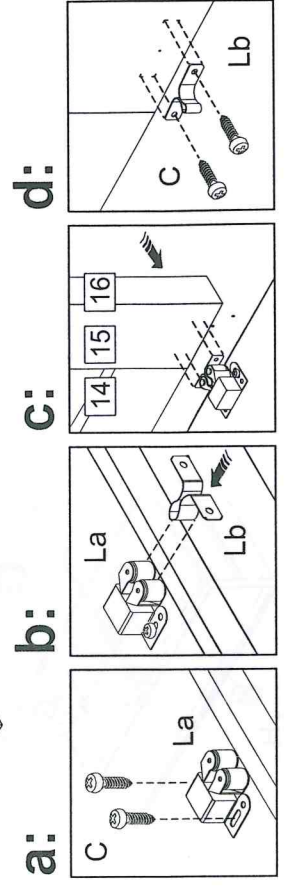
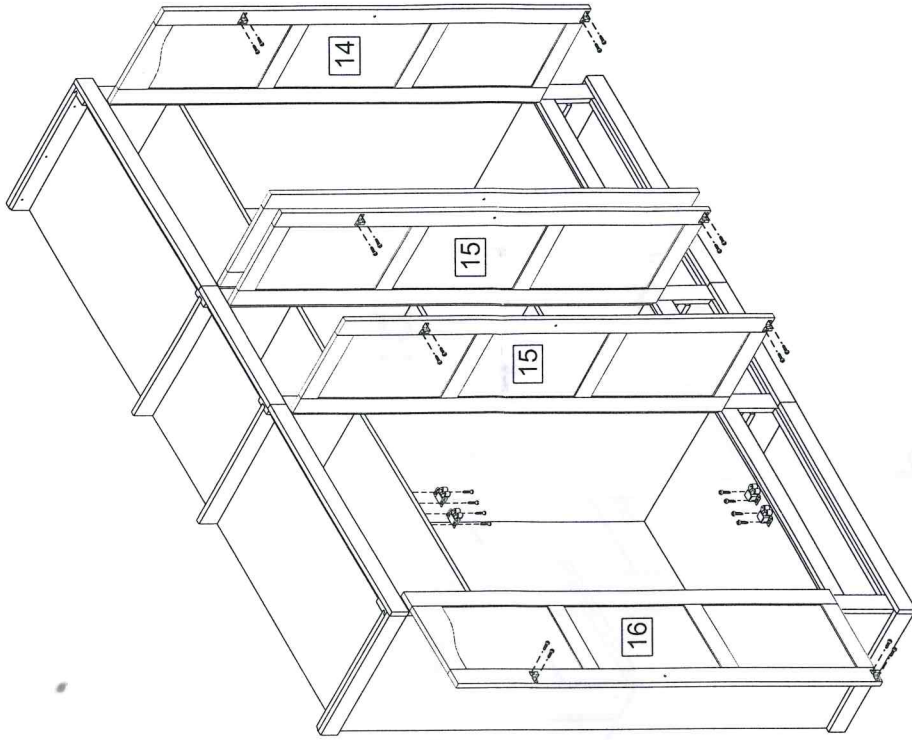

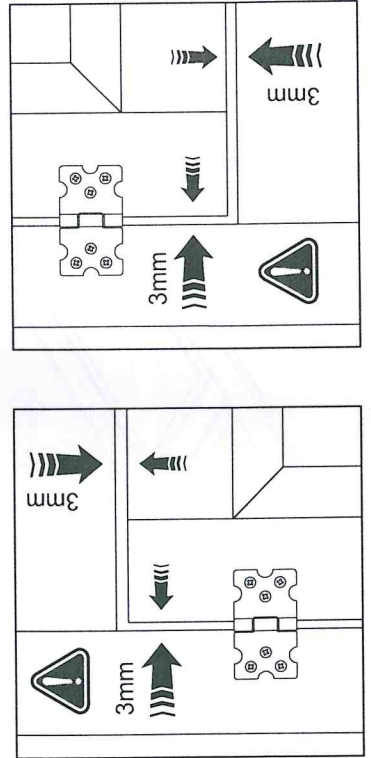
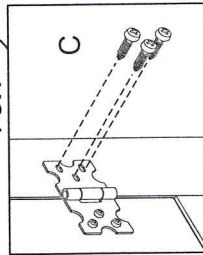
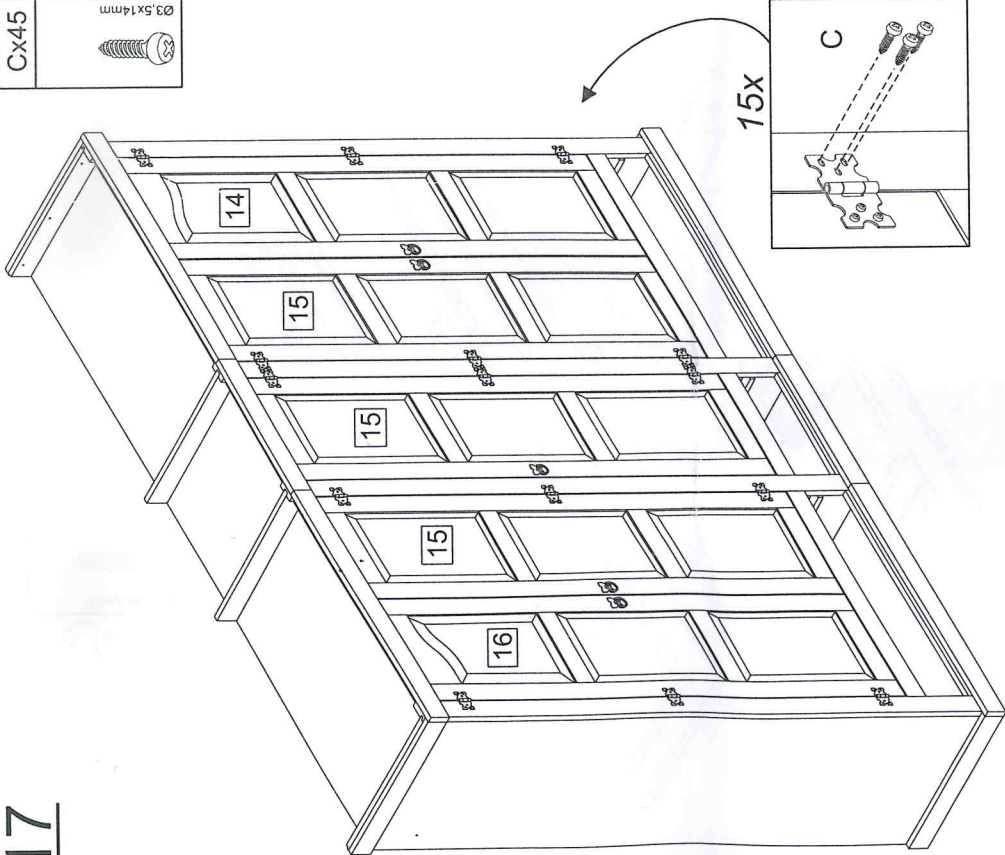

17

Cx45	$\varnothing 3,5 \times 14 \text{mm}$
	

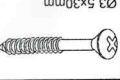

19

3x

DX24		Gx5		Hx5	
	Ø3,5x30mm		Ø4,8x19mm		

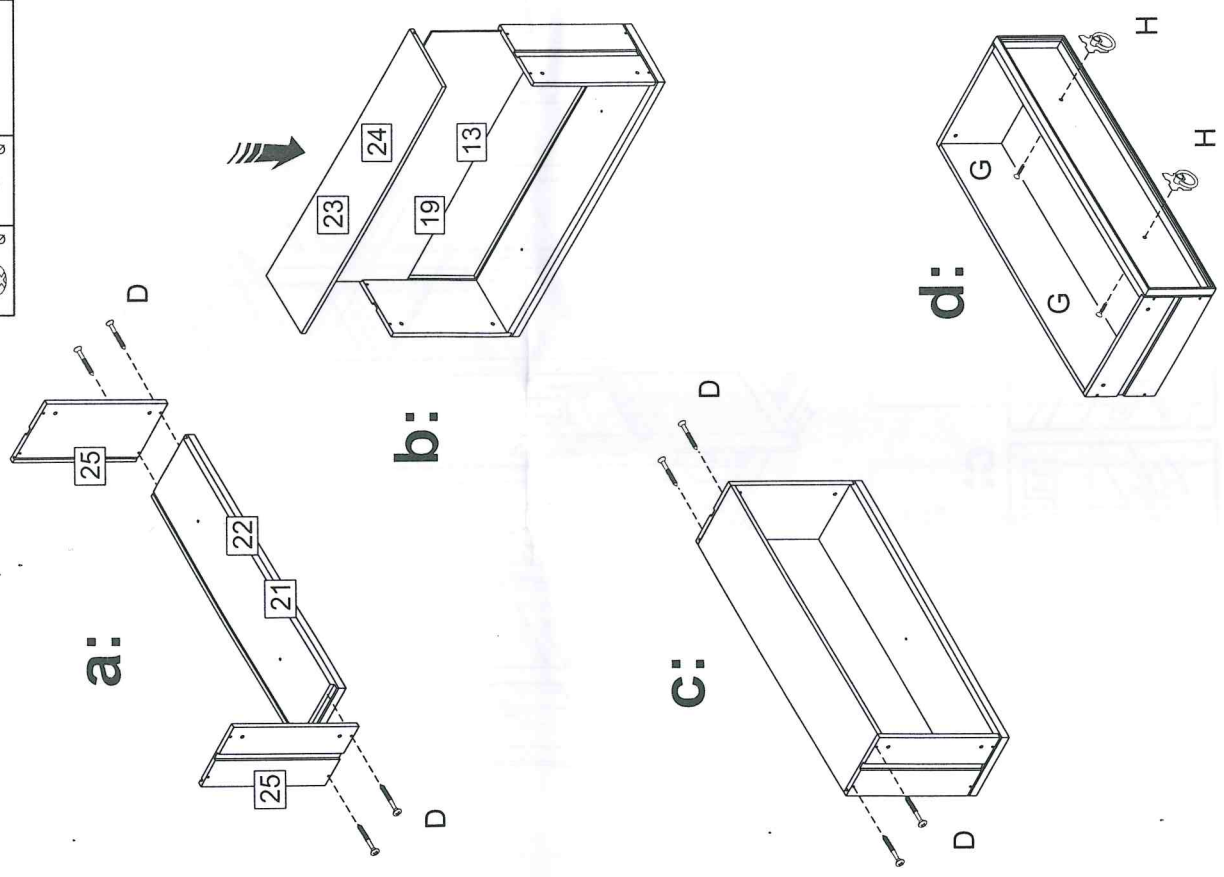

20

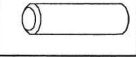
Ax6		Ø8x30mm
-----	---	---------

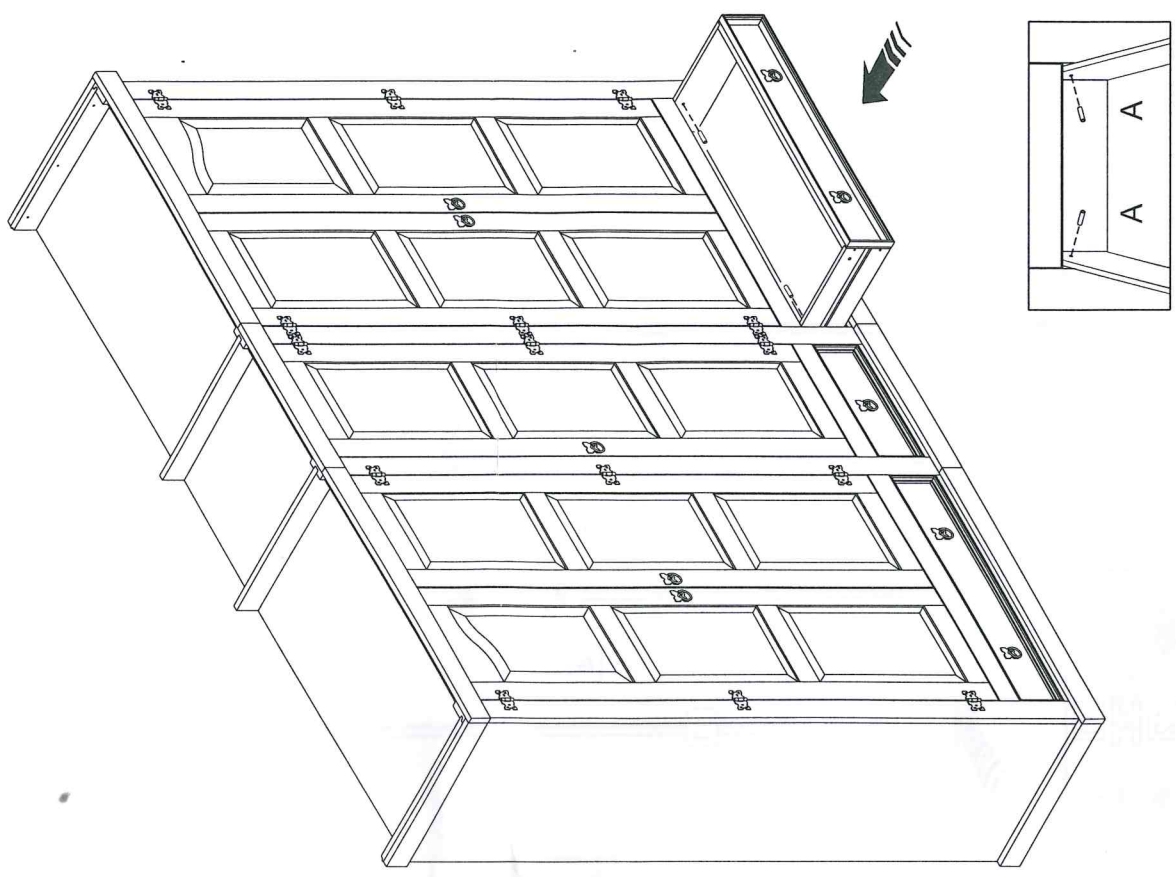

Px100

